

CE



Computer wheel balancer
Model TROLL 2305 MICRO
Operation and Maintenance Manual



Manufacturing – Sale – Maintenance
UNI-TROL Sp. z o.o.
ul. Estrady 56
01-932 Warsaw, Poland
tel./fax (+4822) 8179422, 8349013, 8349014

Operation and Maintenance Manual

Passenger car and light truck wheel balancer

MODEL TROLL 2305 MICRO

Serial number

Year of manufacturing

MANUFACTURER:

UNI-TROL Sp. z o.o.

ul. Estrady 56

01-932 Warsaw

tel./fax (+4822) 8179422, 8349013, 8349014

AUTHORISED SERVICE CENTRE

UNI - TROL Sp. z o.o.

Factory Service Centre

ul. Estrady 56

01-932 Warsaw

tel./fax (+4822) 8179422, 8349013, 8349014 ext. 131

serwis@unitrol.pl

CONTENTS

I. PACKAGING, TRANSPORTATION AND STORAGE

II. INTRODUCTION

Chapter 1 DESCRIPTION OF THE MACHINE

Chapter 2 TECHNICAL SPECIFICATIONS

Chapter 3 SAFETY

Chapter 4 INSTALLATION

Chapter 5 DESCRIPTION OF SUBPROGRAMMES

Chapter 6 NOTES ON OPERATION

Chapter 7 MAINTENANCE

Chapter 8 MACHINE SCRAPPING

Chapter 9 TROUBLESHOOTING

III. SPARE PARTS CATALOGUE

THE MANUFACTURER RESERVES THE RIGHT TO MAKE MODERNIZATION CHANGES TO ITS PRODUCT WITHOUT ANY OBLIGATION TO MAKE SUCH CHANGES IN THIS MANUAL.

I. PACKAGING, TRANSPORTATION AND STORAGE

CAUTION

Any operations related to packaging, lifting, moving, transportation and unpacking must be performed only by qualified staff.

Packaging

The wheel balancer is dispatched as a complete machine (quick adapter, casing, wheel balancer). Rubber pads, calibration device and the manual.

The wheel balancer may be packaged in several ways:

- Pallet + stretch film +cardboard box
- Pallet + stretch film
- Pallet + cardboard box
- Stretch film



Transportation

The packaging must be lifted or moved by means of forklift or pallet trucks. Upon delivery of the load to the place of destination it is required to check if it has not been damaged during transportation. It is also necessary to check completeness of the delivery against the waybill. If the shipment is found to be short or damaged during transportation, it is necessary to immediately report the fact to the person responsible or carrier.

Furthermore, special care must be taken when unloading the shipment.



Storage

The machine should be stored in a dry and dust-free place.

II. INTRODUCTION



WARNING

This manual is addressed to workshop staff who are authorised to operate a wheel balancer (an operator) as well as to workers performing on-going maintenance; read this manual thoroughly before starting unpacking and operation of the wheel balancer. The manual contains important information pertaining to:

PERSONAL SAFETY of operators and maintenance workers, OPERATION OF THE WHEEL BALANCER,



Storage of the manual

The manual constitutes an integral part of the wheel balancer and should be kept near it at all times, even if the machine is sold.

The manual must be kept near the machine in a readily and immediately accessible location. The Operators and maintenance staff must have an immediate access to the manual at all time.

CAUTION



IT IS PARTICULARLY RECOMMENDED TO READ THOROUGHLY AND REPEATEDLY CHAPTER 3 WHICH CONTAINS IMPORTANT INFORMATION AND WARNINGS RELATED TO SAFETY.

The machine was designed and created according to the following documents:

Directives 2006/42/CE, 2006/95/CE, 2004/108/CE and

Polish standards adequate European regulations:

- **PN-EN ISO 12100-1:2005** Safety of machinery. Basic concepts, general principles for design. Part 1: Basic terminology, methodology
- **PN-EN ISO 12100-2:2005** Safety of machinery.. Basic concepts, general principles for design. Part 2: Technical principles (orig.)
- **PN-EN 61000-6-3:2002** Electromagnetic compatibility (EMC). Part 6-3: Generic standards. Emission standard for residential, commercial and light industrial (orig.)
- **PN-EN 61000-6-4:2002** Electromagnetic compatibility (EMC). Part 6-4: Generic standards. Emission standard for industrial environments (orig.)
- **PN-EN ISO 13857:2008** Safety of machinery. Safety distances to prevent reaching the upper limbs and lower the danger zones (orig.)
- **PN-EN 349+A1:2008** Safety of machinery. Minimum gaps to avoid crushing of parts of human body.
- **PN-EN 60204-1:2006** Safety of machinery. Electrical equipment of machines. Part 1:General requirement(orig.)
- **PN - EN 61293 / 2000** Marking of electrical equipment with ratings related to electrical supply - Safety requirements;
- **PN-EN 983+A1:2008** Safety of machinery - Safety requirements for hydraulic and pneumatic systems and their components-Pneumatics (orig.)
- **PN - EN 61204 / 2001** Low voltage DC - Properties and safety requirements;
- **PN-EN ISO 11201:1999** Acoustics - Noise emitted by machinery and equipment - Measurement levels of sound pressure emission at a work station and other specified positions by engineering method .
- **PN-EN 50419 -1:2008** Marking of electrical and electronic equipment in accordance with Article 11 (2) of Directive 2002/96/CE (WEEE)
- **PN-EN 61190-1 -3:2008** Materials for connecting electronic components - Part 1-3: Particular requirements for solders for electronic applications and solders with fluxes or without fluxes for soldering electronic components .
- **PN-EN 61760-1 :2006** Surface mounting technology - Part 1: Method qualification standard components for surface mount (SMD)



CAUTION

Lifting, transportation, unpacking, assembly, installation, start-up, preliminary adjustment, testing, maintenance do not require presence of service workers, but must be performed with special care.

The manufacturer shall not be liable for any personal injuries or damages of vehicles or any other objects, if any of the aforementioned operations have been performed in a manner non-compliant with this manual, or if the wheel balancer has been used improperly.

The manual includes only these maintenance and safety aspects which may help an operator or maintenance worker to understand better the construction and operation of the wheel balancer as well as to use it most efficiently.

In order to understand the terminology used in the manual, the operator must have specific experience in workshop, service, maintenance and repair works, ability to interpret correctly the drawings and descriptions included herein and knowledge of general and specific safety regulations applicable in the country of installation.

The word “operator” used in this manual should be understood as follows: OPERATOR: a person authorised to operate the wheel balancer.

CHAPTER 1 DESCRIPTION OF THE MACHINE

The wheel balancer TROLL - 2305 is intended to be used to balance dynamically passenger car and light truck wheels within one measuring run.

- 1. power switch
- 2. distance gauge
- 3. rubber pads
- 4. feeder
- 5. quick adapter
- 6. keyboard
- 7. foot brake pedal
- 8. calibration device



Indicator screen





Fig. 1



Description of keyboard (fig. 1 and 2)

Verbal messages generated by the wheel balancer upon pressing a button are provided in square brackets.

 Button setting the width of a wheel to be balanced [WIDTH]

 Button setting diameter and distance of a wheel to be balanced [DIAMETER] or [DISTANCE]

 Button of selection of weights mounting manner with diode signalisation [RIM TYPE CHANGE]

 -  **Memory button M1 – M3 [MEMORY READOUT]**

 Button changing parameters of distance, diameter, distance of a wheel to be balanced (decreasing the values)

 Button changing parameters of distance, diameter, distance of a wheel to be balanced (increasing the values)

 Button deleting the result of the last measurement [NEW MEASUREMENT]

 Button of the wheel balancer calibration [CALIBRATION]

 Button starting the “hidden weight” programme

 Button of calculation of imbalances [CALCULATION OF IMBALANCES]

 Button of selection of the cut-off threshold [THRESHOLD CHANGE] — with diode signalisation

 Function button

programme 1:	both weights clipped to the rim edge
programme 2:	both stick-on weights
programme 3:	one weight clipped on the inner correction plane; the other weight stuck to the outer correction plane
programme 4:	static balancing (for thin rims, with one weight), not recommended for car wheels
programme 5:	both weights stuck to inner side of the rim
programme 6:	one weight attached on the inner correction plane; the other weight stuck to the inner side of the rim

CAUTION:

Every instance of pressing any of the buttons is confirmed by a sound signal.

WARNING



The wheel balancer was designed and manufactured to be used to dynamically balance passenger car and light truck wheels. It is prohibited to use it in any other way. The wheel balancer should not be used to wash wheels.

CHAPTER 2 TECHNICAL SPECIFICATIONS

Technical data



- max. tyre diameter	0.9 m
- rim diameter capacity	10" – 30"
- rim width capacity	2" – 15"
- weight imbalance volume indications accuracy	1g
- weight imbalance placement signalisation accuracy	3 degrees
- measurement time	6–7 sec.
- weight of the machine	ca. 50 kg
- machine dimensions: with adapter	77x60x33 cm
- wheel weight capacity	up to 60 kg
- shaft rotational speed (during measurement)	95–130 rpm
- shaft rotational speed (calibration with a wheel)	115 rpm
- shaft rotational speed (calibration with device)	125 rpm
- power supply	230 V / 50 Hz

CHAPTER 3 SAFETY



WARNING

The following chapter must be read in its entirety, since it provides important information concerning danger for the operator and other people in the case of improper use of the machine.

Explanations concerning threats and hazards that may occur during operation and maintenance of the wheel balancer as well as general and specific precautions intended to eliminate the potential dangers are provided below.

Before starting work with TROLL 2305, it is necessary to read carefully and understand these instructions.



WARNING

The wheel balancer TROLL 2305 is intended to be used to balance passenger car and light truck wheels within one measuring run.

It is prohibited to use it in any other way. In particular, the wheel balancer is not suitable for:

- using for purposes other than balancing
- balancing heavy truck wheels

CAUTION



The manufacturer and vendor shall not be liable for any personal injuries or damages to vehicles or any other objects caused by improper or unauthorised use of the wheel balancer.



CAUTION

IT IS NOT RECOMMENDED TO USE THE WHEEL BALANCER WITHOUT PRIOR CLOSURE OF THE WHEEL GUARD.

FAILURE TO MEET THE AFOREMENTIONED REQUIREMENTS MAY RESULT IN SERIOUS PERSONAL INJURIES AND IRREPARABLE DAMAGE TO THE WHEEL BALANCER AND THE WHEEL.

General precautions

The operator and maintenance worker are required to follow the safety regulations applicable in the country of the machine installation.



The manual contains the following captions concerning safety:

Danger — indicates a possibility of danger which may lead to serious injuries

Warning — indicates dangerous situations and/or types of manoeuvres which may lead to major or minor injuries

Caution — indicates dangerous situations and/or types of manoeuvres which may lead to minor injuries and/or damage to the wheel balancer, wheel or any other objects

Electric shock risk — a specific caption placed on the machine where there is particularly high risk of electric shock.

Hazards for staff

The paragraph describes possible threats for the operator or any other people present near the wheel balancer caused by its improper use.

Risk of hitting

There is a risk of hitting the component of the machine.

In the event when the guard is opened, the staff must take special care not to hit themselves at the components of the machine.

Risk of wheel getting loose

Before starting any balancing procedure, it is very important that the wheel is mounted on the adapter.

CAUTION!



**NEVER REMOVE THE WHEEL DURING OPERATION OF THE MACHINE.
NEVER LEAVE THE MACHINE UNATTENDED WHILE IT IS IN OPERATION.**

Risk of slipping



Danger caused by contamination of the floor around the machine with lubricants.



AREA UNDER THE WHEEL BALANCER AND IN ITS DIRECT SURROUNDING AS WELL AS THE ADAPTERS MUST BE KEPT CLEAN AT ALL TIMES.

Immediately remove any oil stains. _____



Risk of electric shock

Danger of electric shock in the areas where electric wiring is routed.

It is forbidden to use water or vapour atomizers (high pressure washing equipment), solvents or paints near the machine. These substances must not be allowed to spread to the control panel.

Dangers caused by inadequate lighting

The operator and maintenance worker must be able to inspect if all the areas of the machine are correctly and evenly lit, in accordance with the regulations applicable in the country of installation.

Risk of damaging a component of the wheel balancer while it is in operation

In order to manufacture a reliable and safe wheel balancer, the manufacturer used appropriate materials and manufacturing techniques adopted to the specified application of the machine. However, it should be noted that the wheel balancer must be operated in compliance with the manufacturer's recommendations. It is required to perform technical inspections with a specified frequency (upon expiry of the warranty period) and maintenance works described in Chapter 7 "MAINTENANCE".

Never exceed admissible weight capacity of the balancer — i.e. 60 kg.

IMPORTANT



Every use of the wheel balancer in a manner contrary to its intended purpose shall entail the danger of causing serious injuries and accidents. Therefore, it is particularly significant to strictly apply any and all recommendations concerning operation, maintenance and safety, stipulated in this manual.

CHAPTER 4 INSTALLATION

WARNING



The following operations may be performed only by persons who were previously trained to operate the machine to which this manual pertains.

In order to prevent potential damage to the balancer or hazard of causing personal injuries, it is necessary to carefully follow the instructions below. It must be ensured that no people are present within the working field.

Requirements regarding installation

The wheel balancer must be installed in the safe distance from walls, columns and other devices.

The site must be equipped in advance with the power supply source and compressed air system. The wheel balancer may be placed on any even, stable and dry floor.

All the parts must be uniformly lit with the light sufficient to safely perform all the operational, adjustment and maintenance operations mentioned in this manual. Presence of any shaded areas, light reflections and blinding light is inadmissible; any situations which may cause eye strain should be avoided.

Lighting must be installed in accordance with the regulations applicable in the place of installation (the lighting contractor shall bear this liability).

Prior to installing, all the parts must be unpacked and inspected for any signs of damage.

Issues regarding manoeuvring and lifting are discussed in the chapter "Packaging, transportation and storage".

Place of installation



The wheel balancer TROLL - 2305H must be installed in a closed and dry place which will be heated in the autumn and winter period. The machine should be installed on a stable level floor. The wheel balancer should be installed on four rubber pads enclosed which should be placed under the flat legs welded to the machine base. The machine should not be screwed to the floor.

Assembly of the adapter



Before mounting the adapter, it is necessary to clean thoroughly the cone areas of shaft "1" and adapter "2" with an oil-wetted cloth. Mount the adapter onto the shaft so as to maintain the position of markers "3" on the shaft rod and adapter as in fig. 3. Tighten up the adapter to the shaft with the use of screw "4".

CAUTION:



Careful cleaning of the cone areas and maintenance of the adapter position against the shaft (overlapped markers) is one of the conditions for proper wheel balancing. Wheels with a centre hole should be mounted in the standard adapter of the balancer.

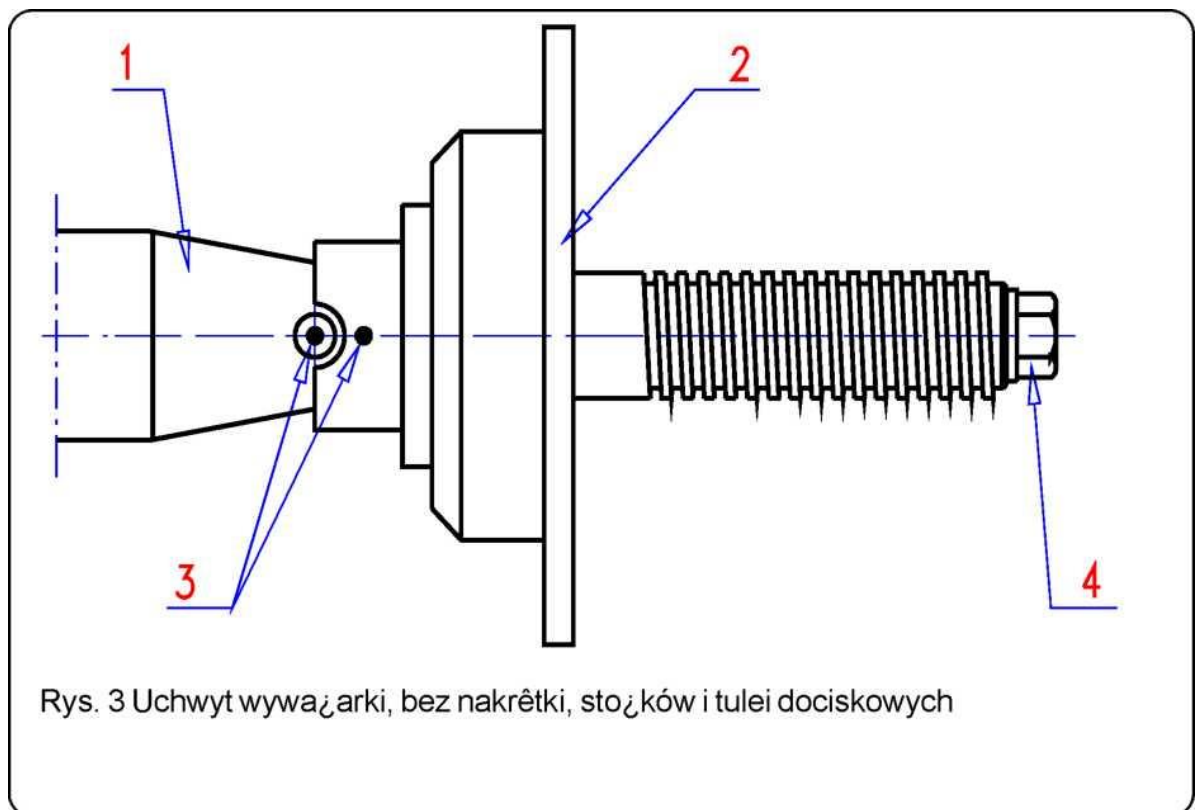

Fig. 3 Adapter of the balancer, without the nut, cones and clamping sleeves

Components of the adapter set



1 –

adapter; a – stud, b – flange

2 – screw for mounting the adapter on the shaft

3 – spring

4 – clamp nut

5 – centring cone No 2 1 43–82 mm 06.04.046 — W-St-6

6 – centring cone No 2 65–111 mm 06.04.047 — W-St-7

7 – nut clamp

8 – centring disc No 1 (with double cone)** 125–145 mm 06.04.017 W-St-5

9 – centring disc No 2 (with double cone)** 145–165 mm 06.04.009 W-St-2

10 – centring cone No 3** 40–57 mm 06.04.046 W-St-3

11 – reduction ring of the adapter**

12 – centring disc No 4 (with double cone)** 110–125 mm 06.04.008 W-St-4

** additional accessories

Clamp nut

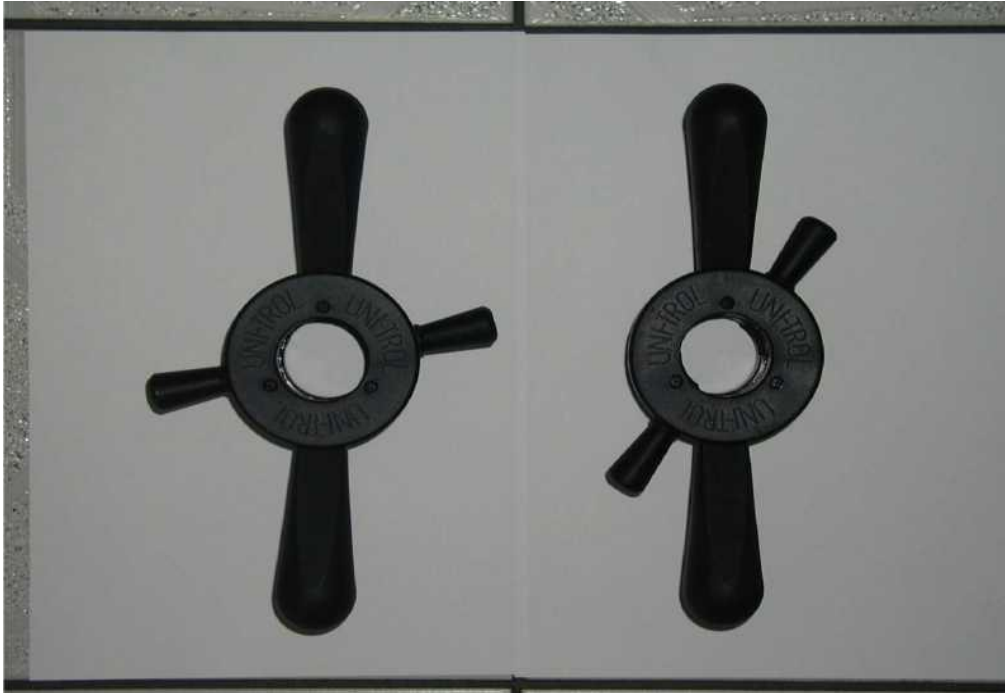

POSITION L (LOOSE)

POSITION D (CLAMP)

Fig. 5

Lever of the clamp nut revolves against the nut body within the limits indicated by a notch in the body (positions **L** and **D**).

In the L position (LOOSE) the nut may be freely moved along the threaded stud of the adapter.

In the D position (CLAMP) the nut may be screwed onto the threaded stud.

Mounting the wheel on the adapter

Slide the wheel onto the adapter stud and position it with the edges of centre hole on the centring cone catch. Set the nut lug in the position LOOSE and screw the nut to the wheel until stop. Placing one's thumbs on the nut rod (as in fig. 6) move lugs to the right to the position CLAMP and tighten up the nut, pressing the wheel towards the faceplate.



Fig.

6

Tightening up the nut

In order to remove the wheel from the adapter, it is necessary (as in fig. 7) to move lugs to the left to the position LOOSE and loosen the nut halfway. It will get loosened and may be removed from the stud and the wheel may be removed from the adapter.



Fig.

7

Loosening the nut

Adapter structure and equipment enabling to mount wheels with various rim shapes and centre hole diameters.

- 1 - use of cone 5 or 6 with centring from the inner side of the rim:
 - nut of adapter "4" should be with a clamp "7" (see fig. 4 and 11)
 - the spring of the cone should be placed in such a way so that the smaller diameter of the springs supported against the cone base (fig. 10)

- 2- - use of cone 5, 6, 8, 9, 10 with centring from the outer side of the rim (as in fig. 8 and fig. 9)
 - nut without clamp
 - adapter without spring



Rys. 8



Rys. 9



Rys. 10

Disassembly of the nut clamp



Fig. 11

If in order to mount the wheel using centring discs and cones in the centring system from the outer side of the rim, it is required to remove the clamp from the nut.

To remove the clamp, it should be pulled axially so that it is removed from the catch; it may be carefully levered with a flathead screwdriver.

To place the clamp back, it should be pushed onto the nut catch.

Electrical connection of the wheel balancer

CAUTION:



Plug the feeder cable into the socket 230V/50Hz.

CAUTION:



SINCE UNEXPECTED WARMING OF FROZEN METAL AND PLASTIC SOLID GENERATES CONSIDERABLE QUANTITIES OF WATER VAPOUR CONDENSATE, IT IS FORBIDDEN TO PLUG IN COOLED WHEEL BALANCER TO THE POWER NETWORK BEFORE THE LAPSE OF 2 TO 3 HOURS REQUIRED TO DRY THE ELECTRONIC ELEMENTS AND THEIR REACHING THE WORKSHOP TEMPERATURE. FAILURE TO COMPLY WITH THIS REQUIREMENT MAY CAUSE DAMAGE TO THE WHEEL BALANCER. And with faulty electrical installation it may cause electric shock.

CHAPTER 5 DESCRIPTION OF SUBPROGRAMMES

5.1 PROGRAMMING THE WHEEL BALANCER COMPUTER





Operation of the wheel balancer computer

The inspection shall be performed with the wheel mounted (tolerably only the rim) on the shaft.

Connection of the wheel balancer computer





Press power switch “1” on the wheel balancer Fig. 2 After completing the control testing, which is signalled with a sound, the measuring indicator screen shall display the icons as in Fig. 1.

5.1.1 Entry of WIDTH parameter

Press the button  on the keyboard. The indicator screen displays symbol  and the value of width recently entered to the memory. By pressing button  and  it is possible to adjust this parameter, every half an inch in a range between 2 and 15 inches.







5.1.2 Entry of DIAMETER parameter

Press the button  on the keyboard. The indicator screen displays symbol  and the value of diameter recently entered to the memory. By pressing button  or  it is possible to adjust this parameter, every inch in a range between 10 and 30 inches.



5.1.3 Entry of DISTANCE parameter

Press the button  on the keyboard. The indicator screen displays symbol  and the value of distance recently entered to the memory. Move controller “1” closer to rim “2” Fig. 12. Read the value of distance and enter it to the memory by pressing  or .



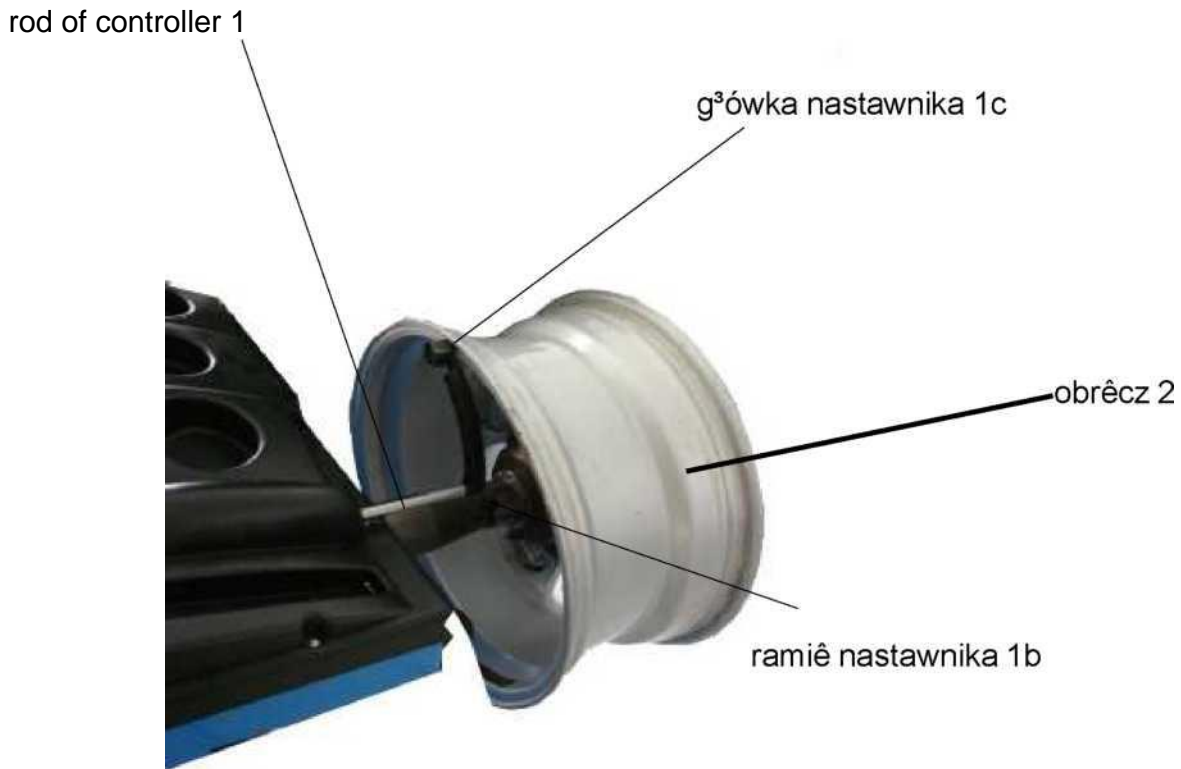

Fig. 12
 1 - controller
 1a - controller rod
 1b - controller arm
 1c - controller head
 2 – rim

5.1.4 Selection of balancing programme

Press ALU button on the keyboard.

In the indicator screen the pictogram  will be set at the height of pictogram . Suitable programme is selected by pressing buttons  or .



option 1:

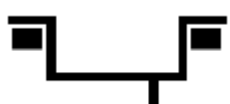

balancing a wheel through clamping weights on both sides of a rim

option 2:



balancing a wheel through sticking weights

option 3:



balancing a wheel through clamping a weight on the inner side of a rim, and sticking another weight on the outer correction plane

option 4:



balancing a wheel through sticking a weight to the inner side of the correction plane, and clamping another weight on the outer side of a rim

option 5:



wheels

static balancing (with one weight for very thin rims); not recommended for car

option 6:



balancing a wheel through sticking weights inside a rim

option 7:





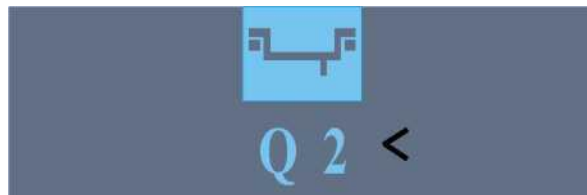

balancing a wheel through clamping one weight on the inner correction plane, and the other weight inside a rim

5.1.5 Entry of the cut-off threshold value

Press the button  on the keyboard.











In the indicator screen the pictogram  will be set at the height of pictogram . The wheel balancer has three values of the cut-off threshold: 2 grams, 5 grams and 40 grams. By pressing button  or  it is possible to increase or decrease the cut-off threshold.

CAUTION

The cut-off threshold [value Q=0] shall be deactivated by pressing button **STOP**, holding and then pressing button **Q**.

5.1.6 Wheel balancer's memory / User's memory

The wheel balancer has two memories: M1, M2, which enable to save parameters for two different wheels. In order to enter data to the memory, e.g. M1, appropriate parameters should be displayed by pressing buttons    and . Then values of the parameters must be set by means of buttons  or . Press button STOP and while holding it press button . Press button  in order to read out the data previously saved in the memory. For other memories, the respective buttons  should be used.

5.1.7 Wheel balancer drive

The wheel balancer has a manual shaft drive. In order to bring up the wheel to proper speed level, hold the ball of the adapter nut and spin the shaft in the direction of the arrow on the wheel balancer casing. The wheel should reach the rotational speed higher than 95 rpm. Value of the rotational speed is displayed in the indicator screen. If the rotational speed does not exceed 95 rpm, the indicator screen shall not display any values and the measuring cycle shall not be initiated.

If after spinning the shaft the obtained speed is higher than 130 rpm, this value shall be displayed in the indicator screen, the measuring cycle shall be initiated when the shaft revolutions slow down to 130 rpm. Completion of the measuring cycle is signalled by displaying the value of imbalance in the indicator screen.

Example:

Obtained rotational speed 125 rpm



5.2 Wheel balancing

Balancing of every wheel consists in determining the volume of imbalance expressed in grams for inner and outer correction plane and localising position of imbalance on the wheel. In order to clearly identify the volume of imbalance, it is necessary to enter the following data into the machine memory: WIDTH, DIAMETER, DISTANCE — corresponding to geometrical dimensions of the wheel to be balanced, select balancing programme (manner and positions of correction weights) and enter the value of the cut-off threshold.

CAUTION

If one wants to balance the wheel whose parameters were previously saved in the memory **M** of the computer, then it is enough to press button **M** to enter data on this wheel.

Upon entering the measuring setpoints, the wheel should be brought up to speed of at least 95 rpm. The measuring cycle is conducted with no interference on the side of the operator and is completed by displaying the value of imbalance in the indicator screen.



The indicator screen displayed exemplary values of imbalance:

- 15 g — applicable to inner left correction plane
- 18 g — applicable to outer right correction plane

spinning the wheel slowly, at each revolution one may hear sound signals slightly different from one another.

They occur in such wheel positions for which the arrows defining the position of imbalance are directed towards one another.

The value of 15 g displayed in the indicator screen means that the weight of 15 g should be attached on the inner edge of the rim in order to balance the imbalance. Watch the arrows while spinning the wheel in any direction. The sound signal shall be heard and arrows directed towards one another only for one position of the wheel against any reference point. For this wheel position, the weight of 15 g should be attached at the topmost point on the inner edge of the rim. The position of attaching weight of 18 g (20 g) on the outer correction plane shall be searched in the same manner.

After attaching weights of particular weight in particular positions perform a control measurement. In theory, the indicator should now display two zeros meaning that the remaining volume of imbalance does not exceed No 5 g, according to the set cut-off threshold. In practice, it does not have to be this way. Why?

Firstly — correction weights, regardless of their type, are produced with certain acceptable deviation in weight.

Secondly — the wheel balancer measures volume of imbalance with the accuracy up to 1 g, and the position of imbalance is defined by means of points with the accuracy up to 3 degrees of angular measure.

Thirdly — a correction weight is not a point mass, but it has certain length — the greater the mass, the greater the length — therefore, while attaching the weight to the rim, it is very easy to make an error of positioning (moving the weight against the topmost point of the rim defined by the machine).

Thus, there may be a case when after a control measurement one gets a result of, for example, 6 g for the inner plane and 7 g for the outer one. What to do next?

Case 1.

The indicator displays value 0. It signifies that the wheel has been balanced with the accuracy up to 5 g, since such a cut-off threshold had been adopted. By pressing button **Q** and setting the cut-off threshold to 2 g, it is possible to identify whether the wheel has been balanced with the accuracy up to 2 g. Such a case occurs when both indicators display value 0. If the indicator displays value 0 and, for example, value 4, it means that the wheel has been balanced with the accuracy of up to 4 g. After pressing button **Q** and resetting the cut-off threshold to 5 g, the indicator screen shall again display value 0.

Case 2.

The following results are obtained in the control measurement: inner correction plane — result 6, outer correction plane — result 7.

Then the wheel is placed according to the new position of imbalance (for each correction plane).

If new position of imbalance is the same as the previous one or it differs to only a small extent, the weight should be larger.

1 – weight 2 – new correction position

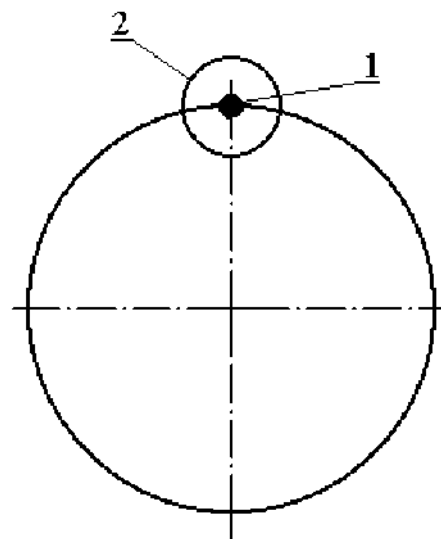

If the new position of imbalance is exactly at the opposite side of the previously attached weight, or it is slightly moved from this point, the weight should be decreased.

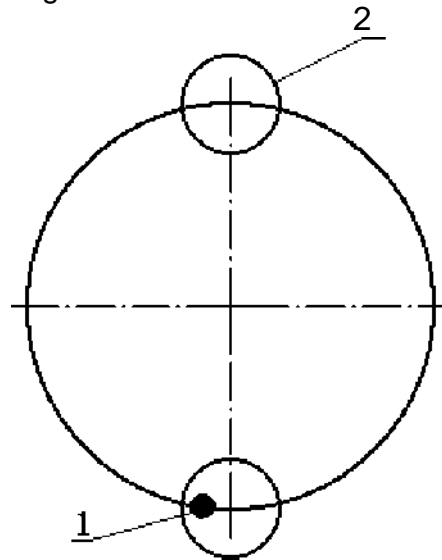

1 – weight

2 – new correction position

If previously attached weight is below the new correction position, it should be moved upwards.

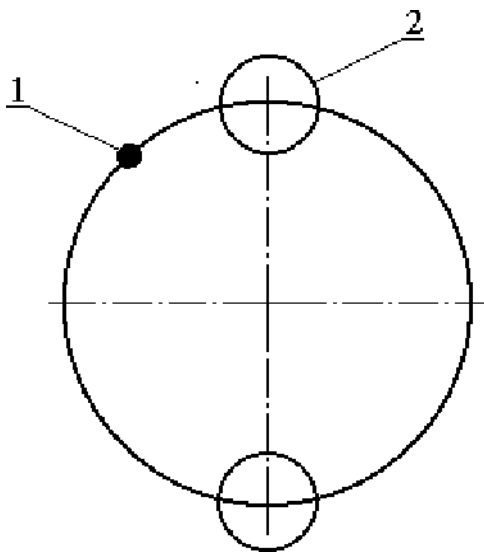

1 – weight

2 – new correction position

It is difficult to clearly identify by what distance the weight should be moved in order to correct the residual imbalance. It depends on the value of imbalance to be corrected as well as the dimensions and position of the mounted weight. In general, it can be said that large weight and residual imbalance requires minor correction of the position.

Note:

If the indicator screen displays 0 (no imbalance), there are no signals regarding the position of imbalance (no arrows).

It may occur that in subsequent measurements of the wheel imbalance, with the cut-off threshold set to e.g. 5 g, the results will change as follows:

- first measurement: 0
- second measurement: 6 g
- third measurement: 0
- etc.

The results are not incorrect. The imbalance is certainly close to the nominal value of the set threshold, i.e. 5 g, and thus the indicator displays alternatively the results 0 or 6. For threshold 10 g, the results may be 0 or 11.

CAUTION

For balancing programmes 5 and 6, the correction weight for outer correction place should be attached in the plane of the faceplate (at the inner side of the rim).

The stick-on weights cannot be removed and stuck again. Therefore, upon displaying the values of imbalance, a weight smaller by 5–10 g than the one indicated by the balancer should be stuck. In the subsequent measurement it is possible to correct the residual imbalance by sticking another, smaller weight (e.g. 5 g) in a new position of imbalance indicated by the wheel balancer. In this manner it is plausible to avoid possible correction of the position by moving the weight, what is undoable for stick-on weights.

5.2.1 Calculation of imbalances

This function enables to quickly obtain the correct values of imbalance in the event when the measurement was performed upon entry of incorrect parameters of a wheel.

Example:

Incorrect data regarding the wheel to be balanced are entered to the machine's memory. The measurement is performed, but the results are not true. If one wants to know the real values of imbalances for this wheel without the necessity to perform another measurement, it suffices

to enter correct data (←, ↓, → | Alu) to the machine's memory and press the button

The wheel balancer will display correct values of imbalances.

5.2.2 "Hidden weight" programme

The "hidden weight" programme is used when the user wants the correction weight for the outer side of the wheel not to be visible in ALU subprogrammes (variant 5 and 6). The programme enables to split the imbalance displayed in the indicator screen between two correction weights which should be stuck behind two arms of the rim (spokes) located in the nearest distance to the left and right from the imbalance position.

Procedure of the "hidden weight" programme

1. Select variant "6" or "7" of the balancing programme.
2. Initiate measuring cycle.
3. After the wheel stops, correct the imbalance for the inner correction plane.
4. Imbalances shown for the outer correction plane should be corrected with the use of two weights according to the following procedure:
 - 4.1. Position the wheel so that the correction position is in the topmost point of the rim (sound signal and arrows directed towards each other).
 - 4.2. Press the button 3P. The indicator screen shall display 3P and Pt-1.

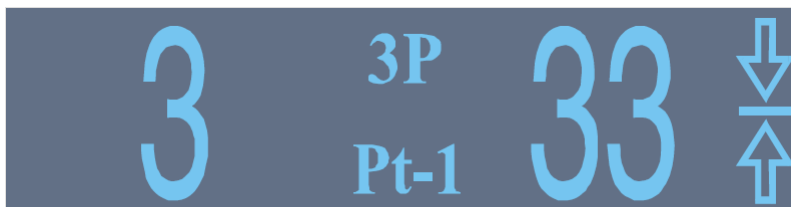

4.3 Spin the wheel to the left to the position defined in point 4.1 until the closest spoke reaches the vertical position. To accept the position press button . The computer shall save the wheel position as a position of sticking the first correction weight. The indicator screen shall display “Pt-2”, i.e. it is necessary to start searching for a point of sticking another correction weight.

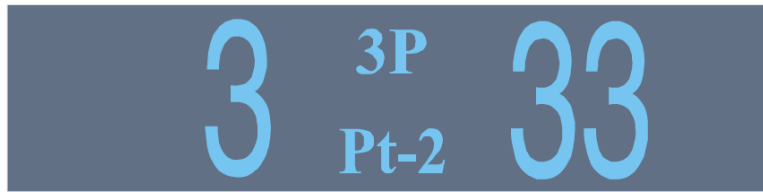

4.4 Spin the wheel to the right to the position defined in point 4.3 until the closest spoke reaches the vertical position. To accept the position press button .

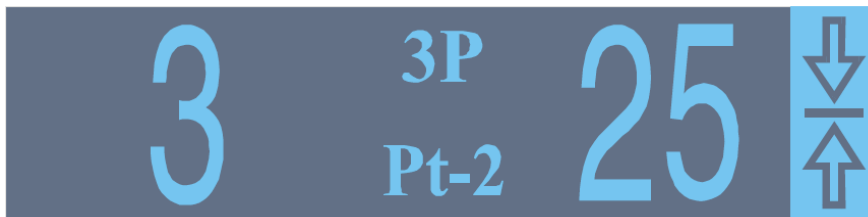

It is a position in which the correction weight of 25 g should be stuck.

4.5 Spin the wheel to the left to the position set in point 4.1. The moment of reaching proper position of the wheel is signalled by a sound, displaying of values of imbalance and arrows directed toward one another.

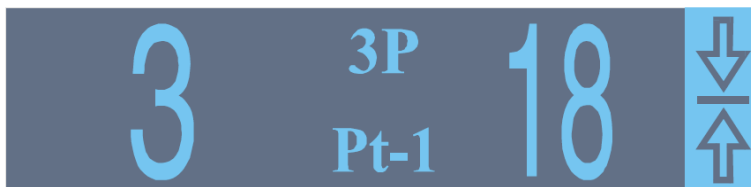

It is a position in which the correction weight of 18 g (20 g) should be stuck.

4.6 After sticking correction weights exit the programme **3P** by pressing button **STOP**. Initiate the measuring cycle and check if the wheel has been properly balanced.

CALIBRATION WITH THE CALIBRATION DEVICE

The wheel balancer is equipped with a self-calibration system enabling the user to tune the machine on its own. Calibration shall be performed in the case of suspicions of incorrect indications displayed by the machine (caused by aging of electronic components, impact of temperature, vibrations in transport, etc.). Calibration of the wheel balancer should be carried out in the following manner:

1. Parameters of setpoints corresponding to parameters of the wheel rim, i.e.

- distance
- diameter 18.0;
- width 5.0, s1 are entered automatically.

2. Mount the calibration device onto the shaft so that the hole of the device is positioned opposite the red pin (2) attached on the shaft.

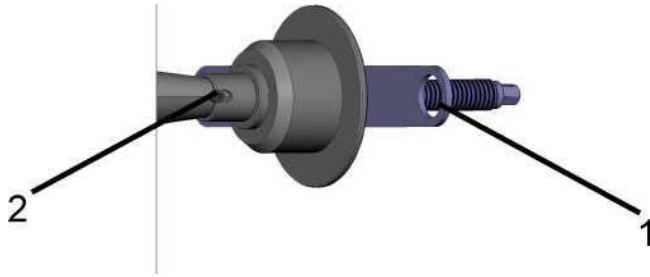

3. Press button CAL i (the indicator screen will display symbol CAL!).



Hold it until hearing a sound signal and displaying the following pictogram



4. Spin the shaft so as to reach the rotational speed of 125 rpm. Calibration cycle starts when the shaft revolutions are brought up to speed of 125 rpm.

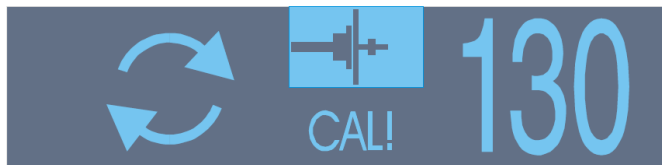

5. Calibration cycle ends when the indicator displays numbers 0 and 79 or 0 and 80.

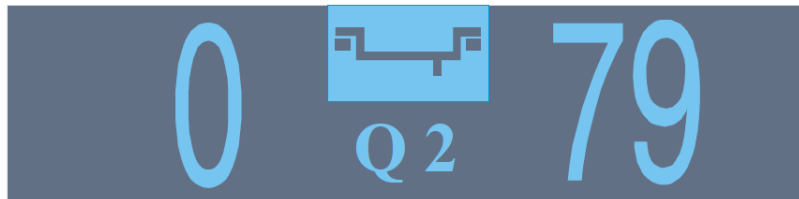

CAUTION:

Any other values signify incorrect calibration. In such a case contact the service centre. If there is no calibration device, the calibration should be performed with the use of a balanced wheel and weight of 80 g.

CALIBRATION WITH THE USE OF A WHEEL

Calibration of the wheel balancer should be carried out in the following manner:

1. For testing, select a wheel with known parameters and possibly minor imbalance and mount it on the adapter.
Enter DIAMETER and WIDTH into the memory of the machine, using suitable buttons on the keyboard.
Parameter DISTANCE should be entered by means of a controller being approached to the edge of the rim.
Set the cut-off threshold to the lowest value, i.e. 2 g.
It should be noted that parameters WIDTH, DIAMETER, DISTANCE and the balancing programme must comply with the parameters of the wheel used for calibration.

2. Attach the weight of 80 g to any point on the rim edge.
3. Press button CAL, release it, then press  , hold it until a sound signal is heard and the following pictogram displayed



4. Spin the shaft so as to reach the rotational speed > 115 rpm. Calibration cycle starts when the shaft revolutions are brought up to the speed of 115 rpm.



5. Calibration cycle ends when the indicator displays numbers 0–79 or 0–80.



CHAPTER 6 NOTES ON OPERATION

After completion of balancing and removing the wheel from the wheel balancer, the weights must be permanently stuck to the edge of the rim.

In case of considerable imbalance in one of the planes — e.g. 90 g and minor imbalance in the other one — e.g. 10 g, it is advised to attach only a weight of 90 g and repeat the measurement, since it may turn out that after balancing of this “worse” plane of the wheel the value of imbalance on the other one will drop below the previously obtained value of 10 g.

If the imbalance is greater than 100 g, it is recommended to attach a large weight (e.g. 80 g, 90 g, 100 g) and move it several centimetres aside to the point indicated by the machine. Afterwards, repeat the measurement and attach additional small weight with the weight indicated by the machine.

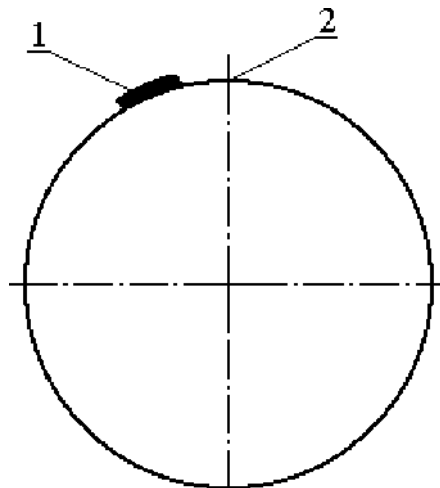

1 – weight of high weight 2 – position of imbalance

If the centre hole in the rim is deformed (e.g. as a result of faulty manufacturing), such a wheel must be balanced in the adapter for wheels with a rim without a centre hole. Such an adapter constitutes an additional accessory to the wheel balancer and can be delivered at the client's special request.

After completion of work switch off the power with master switch “1” — Fig. 1.

It is inadmissible to hold the shaft or adapter of the wheel balancer in transport.

GUARANTEE

The manufacturer shall perform any possible repairs and adjustments. Repair of machines by personnel within the guarantee period without consulting the manufacturer's service centre shall result in loss of guarantee.

The manufacturer reserves the right to make design changes or add improvements to its product, which may result in discrepancies with the information included in this operation manual.

If you have any doubts, please contact us via telephone or email — serwis@unitrol.pl 22 834 90 14 ext. 131

CHAPTER 7 MAINTENANCE

Maintenance must be conducted by experienced personnel with profound knowledge of the principles of operation of the wheel balancer. All precautionary measures must be applied during maintenance operations in order to prevent accidental start-up of the wheel balancer. Master switch must set to 0. In addition it is required to follow any and all instructions provided in chapter 3 "Safety".

PERIODIC MAINTENANCE

In order to maintain the wheel balancer in good technical condition, it is recommended to comply with the following instructions.

FAILURE TO APPLY THESE RECOMMENDATIONS SHALL ABSOLVE THE MANUFACTURER FROM ANY LIABILITY STIPULATED IN THE GUARANTEE.

1. Clean the wheel balancer at least once a month without using chemical cleaning agents and high pressure spray guns.
2. Inspect the technical condition of the machine on a periodic basis.
3. Maintain conical connections on a periodic basis: adapter stud – shaft ending
4. Inspect condition of wiring once a year.
5. It is suggested to integrate pneumatic system with a dewatering filter.

WARNING

ALWAYS REMOVE CONTAMINATIONS AROUND THE WHEEL BALANCER!

CHAPTER 8 MACHINE SCRAPPING

ALL THE PRECAUTIONARY MEASURES DESCRIBED IN CHAPTER 3, APPLIED ALSO DURING ASSEMBLY, MUST BE APPLIED DURING SCRAPPING THE MACHINE.

As in the case of assembly, disassembly must also be performed exclusively by properly trained personnel. Metal parts may be used as metal scrap. In any cases of scrapping, the machine neutralization of all the materials must be conducted in accordance with the regulations applicable in the country of the machine installation.

It should also be noted that for taxation purposes, efficient hibernation of the machine must be documented in reports and forms compliant with the law applicable in the country of the machine installation.

Fire protection

This machine does not pose any fire hazard. In every case, the place in which the wheel balancer is installed must comply with the requirements of fire protection regulations applicable in the county of the machine installation.

It is required to keep one or more portable fire extinguishers within the operator's reach (in the operator zone) so that he is able to stop fire immediately upon its appearance.

Accident prevention

It is necessary to apply all precautionary measures provided for in regulations pertaining to accident prevention applicable in the country of machine installation while lifting/lowering, moving, installing, assembly or disassembly of the wheel balancer. Moreover, all the regulations regarding use of forklift trucks must be applied.

CHAPTER 9 TROUBLESHOOTING

CAUTION

Any precautionary measures described in chapter 3 “SAFETY” and in chapter 7 “MAINTENANCE” must be applied during troubleshooting and repairs.

SIGNS	POSSIBLE CAUSE	SUGGESTED PROCEDURE
The wheel balancer does not generate control messages, indicators do not light	Damage to electric system — no power supply	Check the fuse Check if all electrical connections are in good condition
The engine rotates, while the shaft stays still	No pneumatic supply Damage to the pneumatic system	Check supply pressure Check if all pneumatic connections are in good condition
Load operation of the wheel balancer	Low supply pressure, incorrect tension of the belt	Set proper supply pressure, adjust tension of the belt
The shaft does not stop after completion of the measuring cycle	Damaged plate of the controller transoptors, incorrectly mounted wheel	Blow the transoptors with dry air Correct mounting of the wheel
Unstable, incorrect indications of the distance controller	Damaged plate of the controller transoptors	Blow the transoptors with dry air
Incorrect operation of the guard	Incorrect tension of the shock absorber belt spring	Lubricate the belt Adjust tension of the shock absorber belt spring
Keyboard keys do not activate all functions	Incorrect contact between conductors connecting the keyboard with the indicator plate and the main board, damaged keyboard	Check the sockets, replace the keyboard
Incorrect indications at various mountings of the wheel adapter	Contaminations on the rim, worn centring cone, stud damaged nut, damaged adapter (hit)	Clean dirty elements, replace the cone, replace the nut, replace the adapter

It is always recommended to contact the service centre - serwis@unitrol.pl 22 834 90 14 ext. 131



CE Conformity Declaration

in accordance with directives : 2006/42/CE, 2006/95/CE, 2004/108/CE

We : **Uni-trol Co. Ltd.**
Ul. Estrady 56
01-932 Warsaw
Poland

declare, under our exclusive responsibility, that the product

Wheel balancing machine Electromechanical and pneumatic device model TROLL 2305

Serial number

concerned by this declaration, complies with all relevant requirements of the Machinery Directive:

- **Directive 2006/42/EC (safety machines),**

applicable in the essential requirements and relevant conformity assessment procedures, as well as on the essential requirements of the following directives:

- **Directive 2006/95/CE (the low voltage);**

- **Directive 2004/108/CE (the electromagnetic compatibility).**

For verification of conformity with the provisions of law were consulted the harmonized standards or other norms documents :

- [PN-EN ISO 12100-1:2005](#) Safety of machinery. Basic concepts, general principles for design. Part 1: Basic terminology, methodology
- [PN-EN ISO 12100-2:2005](#) Safety of machinery.. Basic concepts, general principles for design. Part 2: Technical principles (orig.)
- [PN-EN 61000-6-3:2002](#) Electromagnetic compatibility (EMC). Part 6-3: Generic standards. Emission standard for residential, commercial and light industrial (orig.)
- [PN-EN 61000-6-4:2002](#) Electromagnetic compatibility (EMC). Part 6-4: Generic standards. Emission standard for industrial environments (orig.)
- [PN-EN ISO 13857:2008](#) Safety of machinery. Safety distances to prevent reaching the upper limbs and lower the danger zones (orig.)
- [PN-EN 349+A1:2008](#) Safety of machinery. Minimum gaps to avoid crushing of parts of human body (orig.)

- [PN-EN 60204-1:2006](#) requirements (orig.) Safety of machinery. Electrical equipment of machines. Part 1: General requirements;
- [PN - EN 61293 / 2000](#) Marking of electrical equipment with ratings related to electrical supply - Safety requirements;
- [PN-EN 983+A1:2008](#) Safety of machinery - Safety requirements for hydraulic and pneumatic systems and their components-Pneumatics (orig.)
- [PN - EN 61204 / 2001](#) Low voltage DC - Properties and safety requirements;
- [PN-EN ISO 11201:1999](#) Acoustics - Noise emitted by machinery and equipment - Measurement levels of sound pressure emission at a work station and other specified positions by engineering method .
- [PN-EN 50419 -1:2008](#) Marking of electrical and electronic equipment in accordance with Article 11 (2) of Directive 2002/96/CE (WEEE)
- [PN-EN 61190-1 -3:2008](#) Materials for connecting electronic components - Part 1-3: Particular requirements for solders for electronic applications and solders with fluxes or without fluxes for soldering electronic components .
- [PN-EN 61760-1 :2006](#) Surface mounting technology - Part 1: Method qualification standard components for surface mount (SMD)

The technical documentation of this device, referred to in point 1 of Annex VII A of the Machinery Directive, is located in the headquarters Uni-trol Ltd. (address as above) and will be made available to the competent national authorities for at least 10 years after the last piece.

Mr Wiesław Roguski is the person who responsible for the preparation the technical documentation of product and introducing changes in it.

This EC Declaration of Conformity will be kept by the manufacturer of the product for 10 years from the date of produce the last unit and will available for market supervisory authorities for verification.

inż. Wiesław Roguski
Chairman of Board

Warsaw, 10.05.2013

.....
Signature